

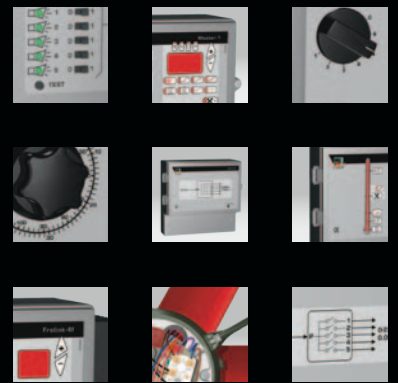

**Vostermans**  
Ventilation

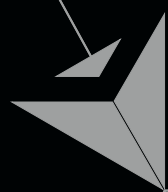

# Mf-Net modular system

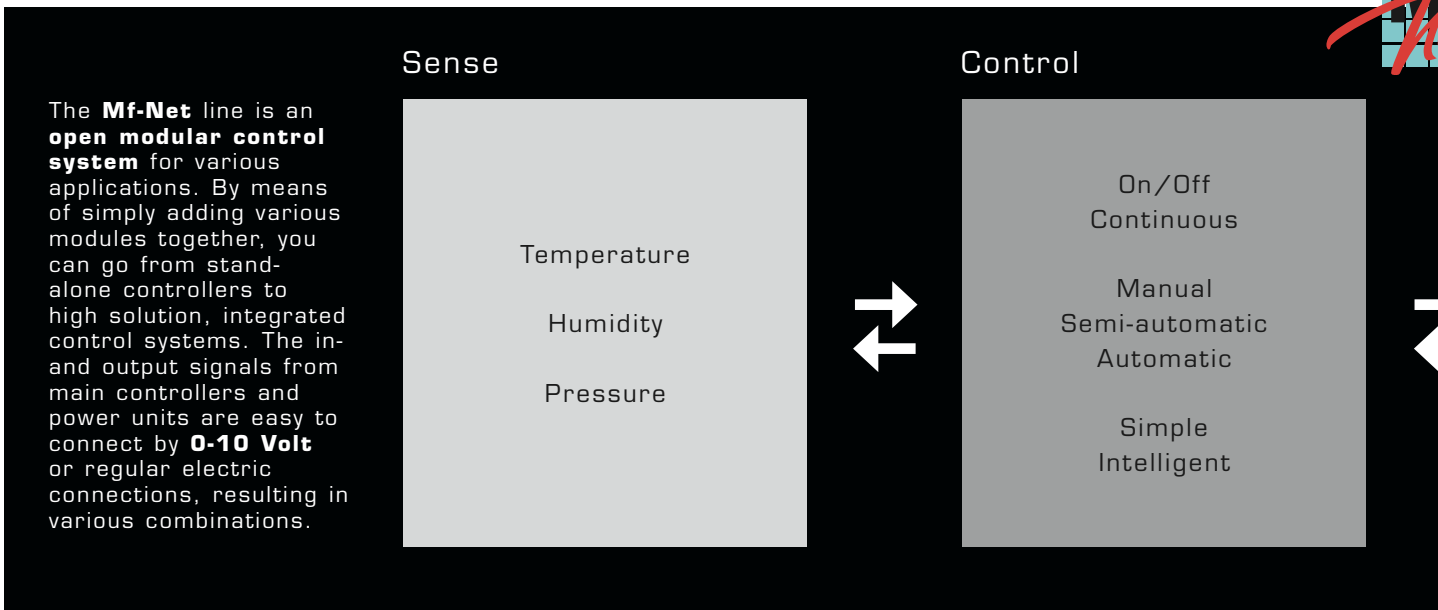

# Mf-Net possible solutions

Solution: Endurance

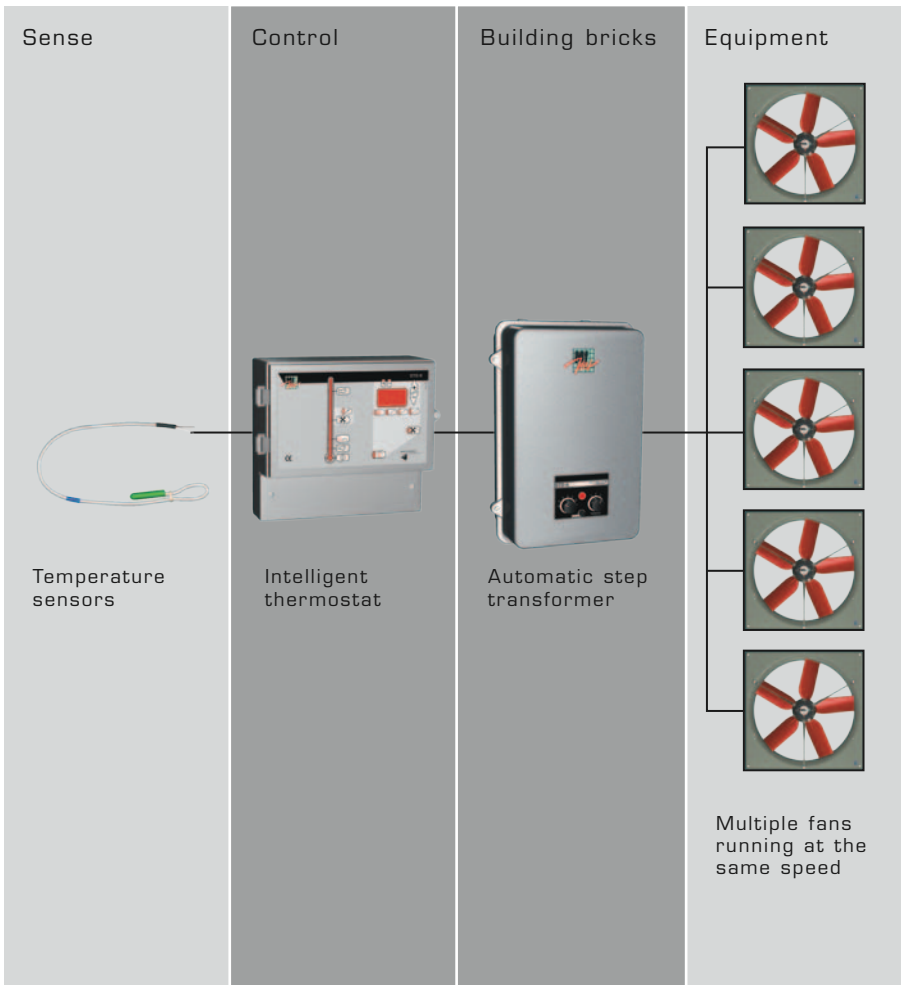

Solution: Endurance & Econ

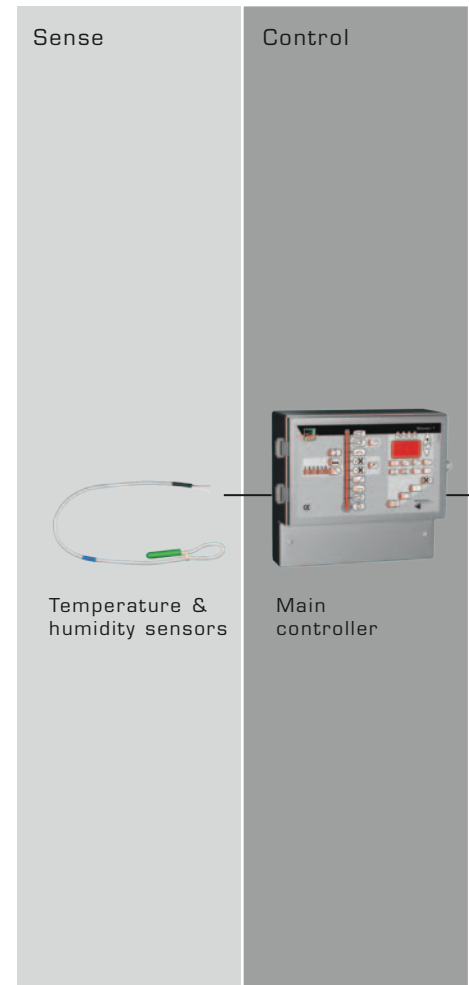



## Building bricks

- Thermostats
- Triac controllers
- Transformers
- Frequency controllers
- Alarm

## Equipment

- Fans
- Heaters
- Coolers
- Inlets
- Lighting
- Alarm

To choose the right combination of **Mf-Net modules** various criteria and specifications can be used. **Mf-Net** offers the following alternative drivers, which can be mixed at free choice:

- Economy:** simple operation, low investment
- Endurance:** robust, durable
- Energy:** energy saving, speed control
- Safety:** reliable alarms

## Economy

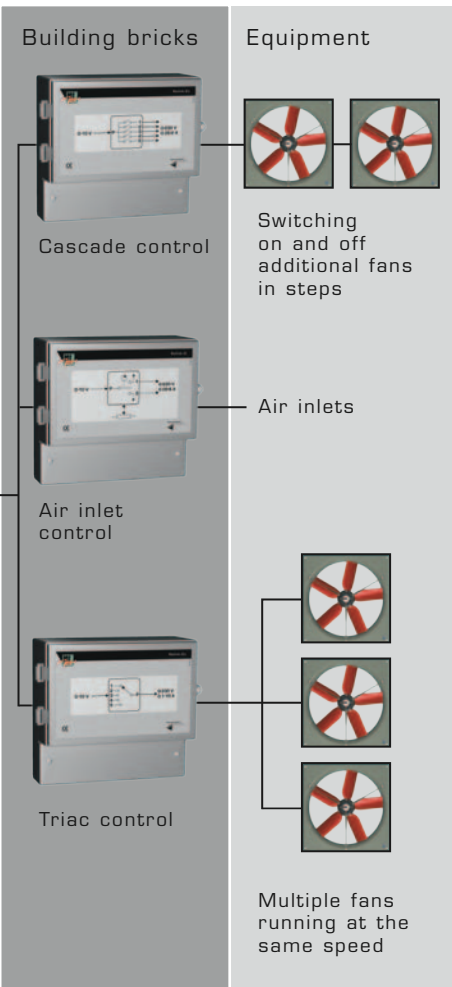

## Solution: Energy

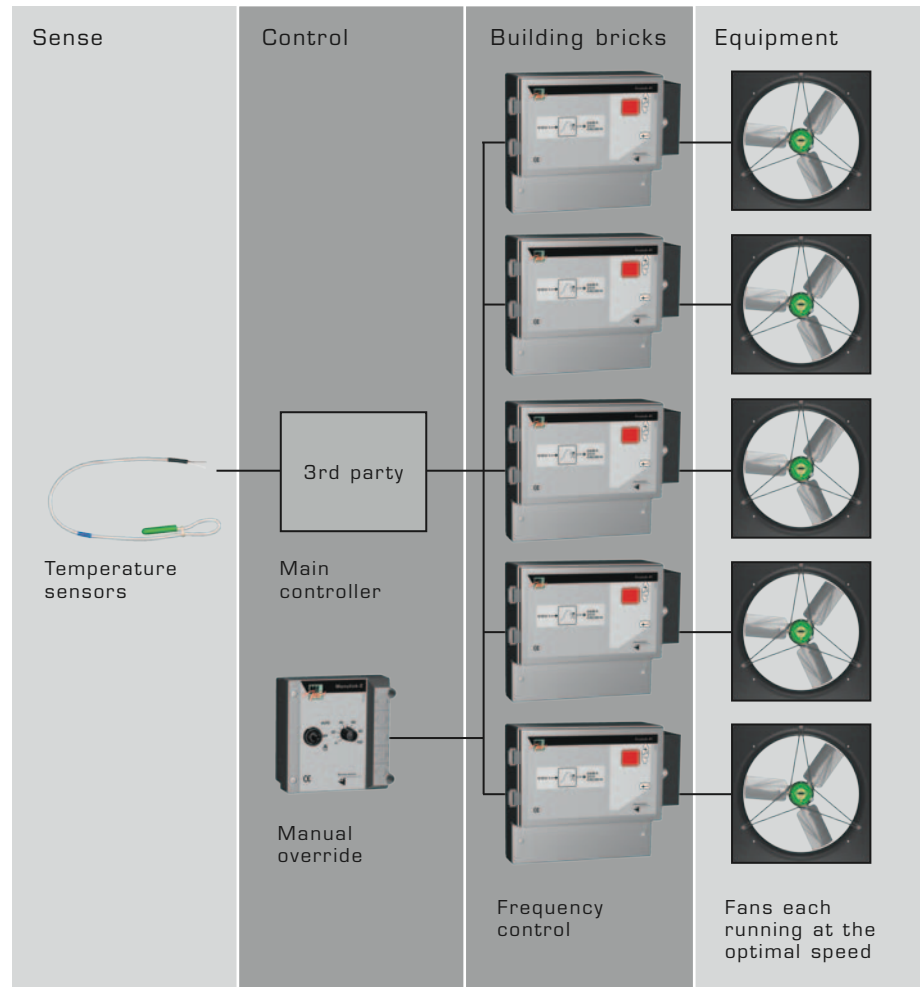

# Mf-Net applications



Reliable and durable performance



Running at the same speed for a uniform climate

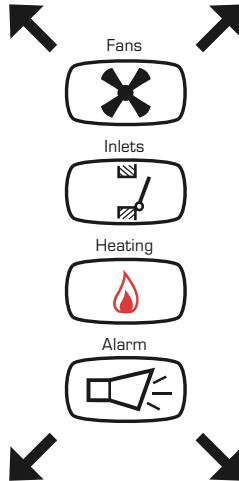

Energy savings at variable speed

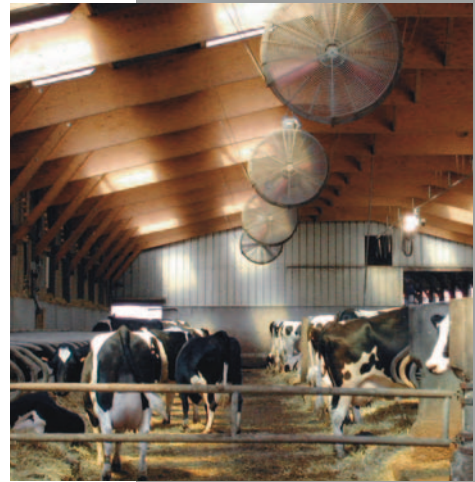

Flexibility for various applications

**Vostermans**  
companies



**Vostermans Ventilation B.V.**  
P.O. Box 3025  
NL-5902 RA Venlo - Holland  
Tel. +31 (0)77 389 32 32  
Fax +31 (0)77 382 08 93  
www.vostermans.com  
ventilation@vostermans.com

**Vostermans Ventilation S.A.R.L.**  
Tel. +33 (0)2 32 38 11 00  
Fax +33 (0)2 32 33 37 12  
www.vostermans.com  
ventilation@vostermansfrance.com

**Vostermans Ventilation Inc.**  
Bloomington, IL 61704 - USA  
Tel. +1 309 827-9798  
Fax +1 309 829-1993  
www.vostermansusa.com  
ventilation@vostermansusa.com

**Vostermans Ventilation Sdn. Bhd.**  
Tel. +60 (0)33324 3638  
Fax +60 (0)33324 1239  
www.vostermans.com  
ventilation@vostermansasia.com

