



## Multifan 130

Through the aerodynamic design of the Multifan 130, Vostermans Ventilation can offer the market a fan with high air volumes (45.600 m<sup>3</sup>/h at 0 Pa) with a very low power consumption (36,9 W/1000 m<sup>3</sup>/h). Tunnel or length ventilated houses demand, through higher product performances higher quantities of fresh air at low cost.

### Advantages

- Designed to allow minimal air losses
- The blades are especially 3-dimensionally shaped providing a maximal air performance of the fan
- Low noise level
- High air flow with minimal effort
- Durability as an asset
- Materials resistant against aggressive climates
- Easy to clean for optimal hygiene
- For higher pressures in poultry- or pig farms (from 60-100 Pa) a 5-blade Multifan 130 is available
- Available with cone fan and with shutter on the inside, providing further possibilities for increasing the airflow capacity

### Optional

- Controllable with frequency controller
- CE-wire guard
- Multiple versions available: 3 blade version, 5-blade version, with cone

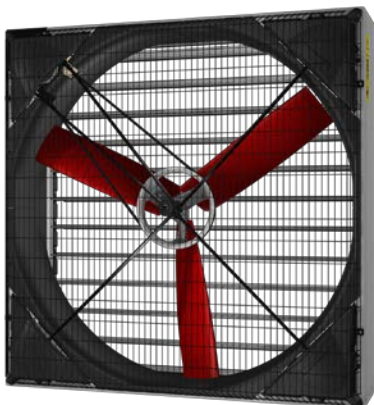

Multifan 130 with 3 blades

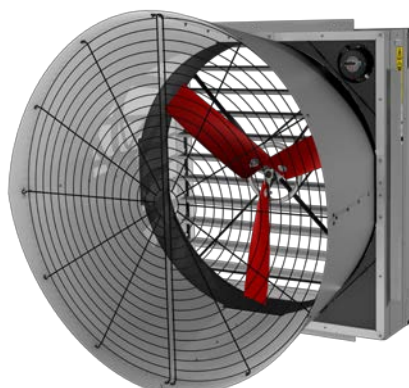

Multifan 130 with Cone



Multifan 130 with 5 blades

# Technical data (1,5 HP Models)

3~ 230/400 V 50 Hz; 240/420 V 60 Hz	P <sub>in</sub>	Q <sub>v</sub> (m <sup>3</sup> /h)						
		0 Pa	20 Pa	40 Pa	60 Pa	80 Pa	90 Pa	100 Pa
Multifan 130 with 3 blades	1650	45.600	41.370	37.030	30.940	-	-	-
Multifan 130 with 5 blades	1650	39.270	36.360	33.410	29.300	26.010	23.790	21.600
Multifan 130 with cone 3 blades	1650	47.470	43.930	39.590	-	-	-	-
Multifan 130 with cone 5 blades	1650	42.570	39.580	36.450	33.290	28.450	25.410	-

3~ 230/400 V 50 Hz; 240/420 V 60 Hz	SFP (W/1000 m <sup>3</sup> /h)	I <sub>nom</sub> Δ / Y		I <sub>max</sub> Δ / Y		L <sub>PA</sub> * dB(A)
		at 0 Pa	50 Hz	50 Hz	60 Hz	
	Multifan 130 with 3 blades	36,9	5,2 / 3,0	5,9 / 3,3	4,8 / 2,8	5,3 / 3,1
Multifan 130 with 5 blades	38,6	5,2 / 3,0	5,9 / 3,3	4,8 / 2,8	5,3 / 3,1	64
Multifan 130 with cone 3 blades	31,8	5,2 / 3,0	5,9 / 3,3	4,8 / 2,8	5,3 / 3,1	64
Multifan 130 with cone 5 blades	34,1	5,2 / 3,0	5,9 / 3,3	4,8 / 2,8	5,3 / 3,1	65

\* Sound pressure level measured at 7 m. free blowing distance.

## Dimensions

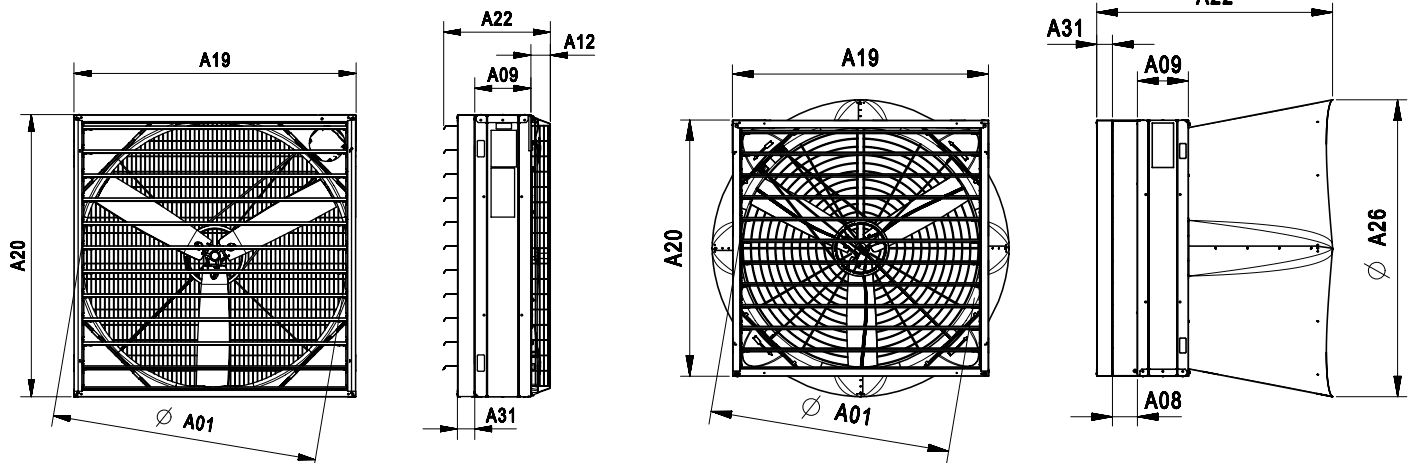

Figure 1: Multifan 130 3 blades and 5 blades

Figure 2: Multifan 130 with cone 3 blades and 5 blades

	Dimensions (mm)								
	A01	A08	A09	A12	A19	A20	A22	A26	A31
Figure 1	1284	-	275	96	1382	1382	523	-	85
Figure 2	1284	135	275	-	1382	1382	1275	1600	85



## VOSTERMANS VENTILATION

Vostermans Ventilation B.V.  
P.O. Box 3025  
NL-5902 RA Venlo – Holland  
Tel. +31 (0)77 389 32 32  
Fax +31 (0)77 382 08 93  
[ventilation@vostermans.com](mailto:ventilation@vostermans.com)  
[www.vostermans.com](http://www.vostermans.com)

Vostermans Ventilation S.A.R.L.  
B.P. 1801  
27018 Evreux Cedex  
France  
Tel. +33 (0)2 32 38 11 00  
Fax +33 (0)2 32 33 37 12  
[ventilation@vostermansfrance.com](mailto:ventilation@vostermansfrance.com)  
[www.vostermans.com](http://www.vostermans.com)

Vostermans Ventilation Inc.  
2439 S.Main St. – USA  
Bloomington, IL 61704  
Tel. +1 309 827 - 9798  
Fax +1 309 829 - 1993  
[ventilation@vostermansusa.com](mailto:ventilation@vostermansusa.com)  
[www.vostermansusa.com](http://www.vostermansusa.com)

Vostermans Ventilation Sdn. Bhd.  
330, Lot 2593, Jln Seruling 59, Kws3,  
Tmn Klang Jaya, 41200, Klang,  
Selangor D.E., Malaysia  
Tel. +60 (0)33324 3638 (HL)  
Fax +60 (0)33324 1239  
[ventilation@vostermansasia.com](mailto:ventilation@vostermansasia.com)  
[www.vostermans.com](http://www.vostermans.com)

Vostermans Ventilation B.V. develops, manufactures and distributes the full line of :

**Multifan**

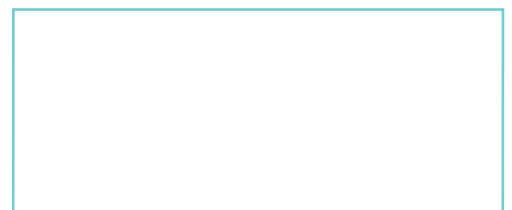

All rights reserved. Vostermans Companies is not responsible for inaccurate or incomplete data. In case of questions and / or regards, please contact [ventilation@vostermans.com](mailto:ventilation@vostermans.com)



Subject to alterations 05/2012